



# PRODUCT GUIDE

## ADS-SEC

---

**DOCUMENT NUMBER**

**REVISION DATE**  
20241104

---

**TERMS OF USE**

Automotive Data Solutions Inc. ("ADS") products are strictly intended for installation by Certified Technicians who are employed by a registered business specialized in the installation of automotive aftermarket electronics products. Prior to beginning installation of an ADS product in a vehicle, it is the Certified Technician's responsibility to review the most current Product Guide, Install Guide and vehicle-specific notes available in Weblink®. ADS is not responsible for any damages whatsoever, including but not limited to any consequential damages, incidental damages, damages for loss of time, loss of earnings, loss of profit, commercial loss, loss of economic opportunity and the like that may or may not have resulted from the use, misuse, improper installation or operation of its products. ADS reserves itself the right to suspend any Weblink® account without notice and decline to offer technical support to non-Certified Technicians, non-compliant Certified Technicians or end users.



# WELCOME

Congratulations on the purchase of your ADS-SEC add-on security kit for iDataStart HC series remote starters. This kit includes a multi-tone siren, a security LED, and a digital multi sensor featuring shock, tilt, and glass break detection.

You are now a few simple steps away from enjoying your new remote starter unit's security kit with enhanced features.

Before starting your installation, please ensure that your ADS-SEC security kit is programmed with the correct firmware and that you carefully review the install guide.

## TABLE OF CONTENTS

### ADS-SEC Product Guide

Security Kit Layout	3
Wiring Diagrams	
Type 1 - Wiring Diagram : ADS-SEC with HCA(320) OR HCA(384)	4
Type 2 - Wiring Diagram : ADS-SEC with HCX(192)	5
Type 3 - Wiring Diagram : ADS-SEC with HCX(512)	6
Starter Kill - Wiring Diagram	7

## NEED HELP?

1 866 427-2999

[support@idatalink.com](mailto:support@idatalink.com)

[idatalink.com/support](https://www.idatalink.com/support)  
[www.12voldata.com/forum](https://www.12voldata.com/forum)  
[www.facebook.com/groups/idatatech](https://www.facebook.com/groups/idatatech)

Scan QR code  
for setup and install video



ADS-SEC SECURITY KIT

**BOX CONTENTS**

- DIGITAL MULTI SENSOR (SEC-DMS)
- SECURITY LED (SEC-LED)
- SIREN (SEC-SIR)
- SIREN ADAPTER (SEC-SIR-ADP)
- HARNESES:
  - DMS ADAPTER CABLE (GREEN TO BROWN 4 PIN)
  - SIREN ADAPTER (3 PIN BLACK)
  - DMS DATA CABLE (BLACK TO BROWN 4 PIN)
- HARDWARE BAG 1:
  - (4) SELF TAPPING SCREWS
  - (2) ZIP TIES
  - (1) SIREN MOUNTING BRACKET
- HARDWARE BAG 2:
  - (4) LOOSE WIRES
  - (1) EMPTY BLACK 12 PIN CONNECTOR HOUSING

**DIGITAL MULTI SENSOR (SEC-DMS)**

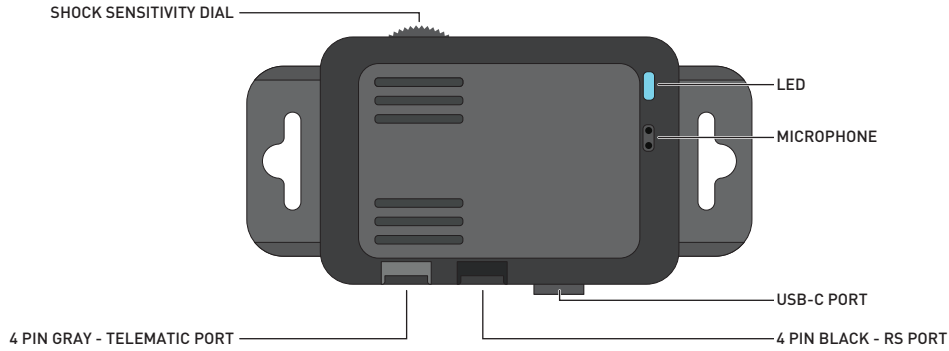

**SIREN ADAPTER (SEC-SIR-ADP)**

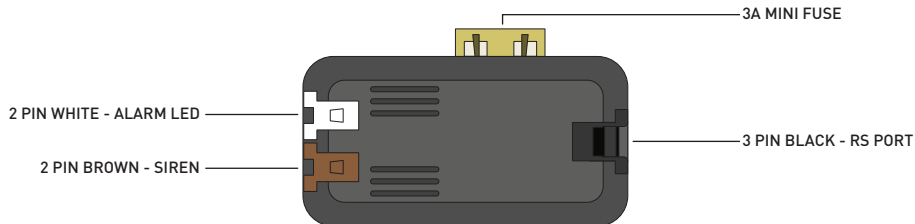

**SIREN (SEC-SIR)**

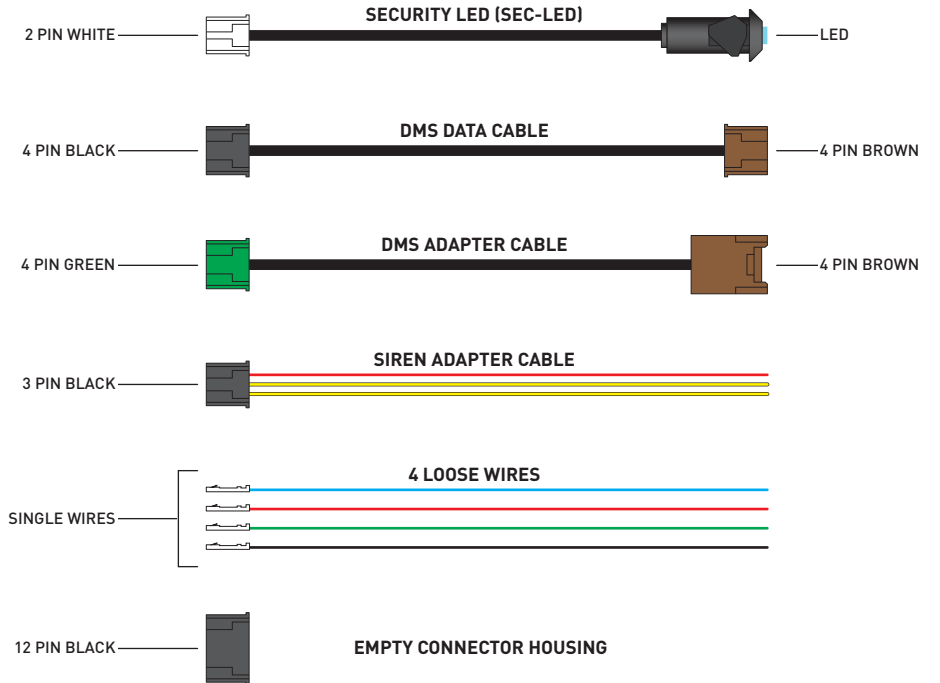
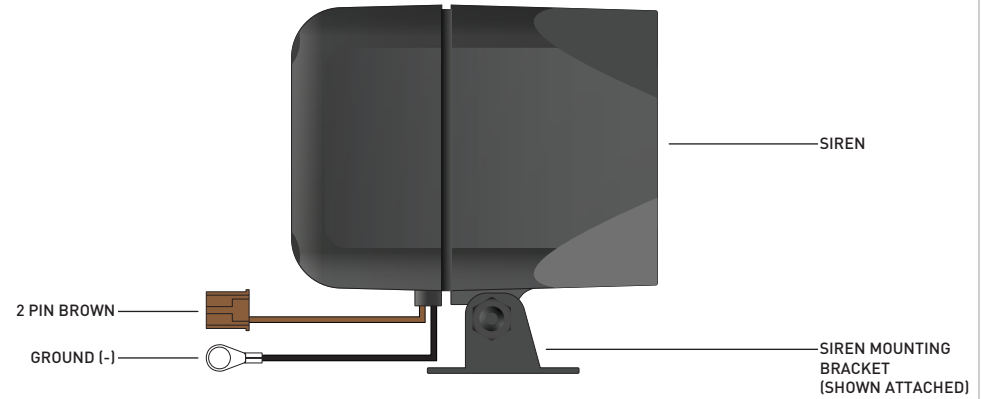

ADS-SEC WITH HCA(320) OR HCA(384)

**STEP 1**

PROGRAM AND CONFIGURE THE HCA(320) OR HCA(384) REMOTE STARTER IN WEBLINK:  
 • ENABLE ALARM FEATURES.  
 • SELECT AND CONFIGURE THE PROGRAMMABLE OUTPUTS (POCS) SHOWN BELOW OR USE ANY AVAILABLE POC. ADD PINS USING THE SUPPLIED WIRES IF NECESSARY. CONFIGURE THE POCs FOR SIREN AND LED TO USE WITH THE SIREN ADAPTER (SEC-SIR-ADP).

HCA(320) OR HCA(384)  
REMOTE STARTER

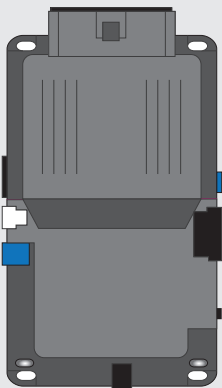

APPLIES TO HCA(320) OR HCA(384) HARDWARE ONLY. SEE THE REMOTE STARTER'S LABEL:

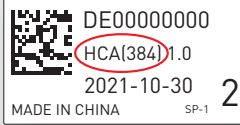

**STEP 2**

PROGRAM AND CONFIGURE THE DIGITAL MULTI SENSOR (SEC-DMS) FOR "DATA" IN WEBLINK

DIGITAL MULTI SENSOR (SEC-DMS)

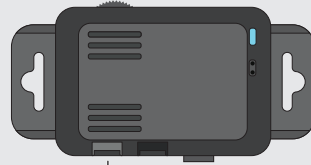

**STEP 4**

IF ALSO INSTALLING A COMPATIBLE TELEMATIC DEVICE, CONNECT TO THE DMS AS SHOWN.

**STEP 5**

ADJUST DMS SHOCK SENSITIVITY USING THE ON-BOARD DIAL (DEFAULT).

**STEP 3**

CONNECT ALL ALARM COMPONENTS AS SHOWN.

SECURITY LED (SEC-LED)

SIREN ADAPTER (SEC-SIR-ADP)

SIREN (SEC-SIR)

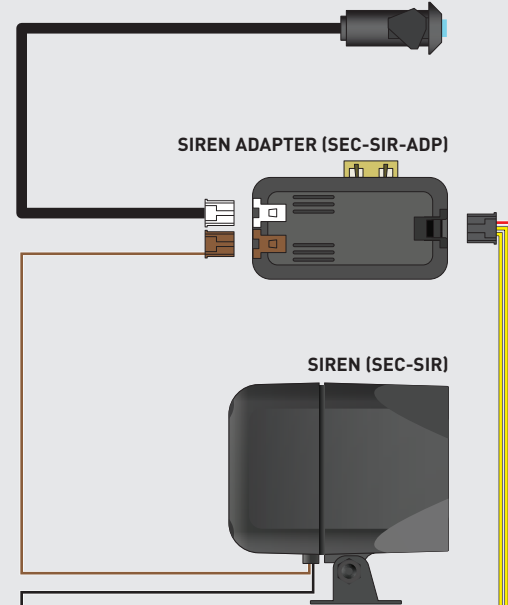

DMS DATA CABLE

INSERT PROVIDED LOOSE WIRES INTO THE BLACK 12 PIN CONNECTOR (M2) IF NEEDED.

- M2 01
- 02
- 03
- 04
- 05
- 06
- 07
- 08 WHITE/PURPLE•BLACK DOT - LED (-)
- 09
- 10 WHITE/BLACK•BLACK DOT - SIREN (-)
- 11
- 12

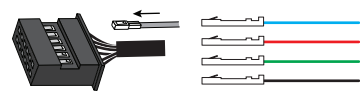
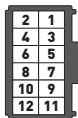

GROUND (-)

- LED (-) INPUT - YELLOW/BLUE
- SIREN (-) INPUT - YELLOW/BROWN
- 12V (+) INPUT - RED

SIREN ADAPTER CABLE



ADS-SEC WITH HCX(192)

**STEP 1**

PROGRAM AND CONFIGURE THE HCX(192) REMOTE STARTER IN WEBLINK:  
 • ENABLE ALARM FEATURES.  
 • SELECT AND CONFIGURE THE PROGRAMMABLE OUTPUTS (POCS) SHOWN BELOW OR USE ANY AVAILABLE POC. ADD PINS USING THE SUPPLIED WIRES IF NECESSARY. CONFIGURE THE POCs FOR SIREN AND LED TO USE WITH THE SIREN ADAPTER (SEC-SIR-ADP).

HCX(192)  
REMOTE STARTER

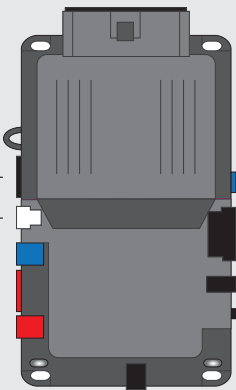

APPLIES TO THE HCX(192) HARDWARE ONLY. SEE THE REMOTE STARTER'S LABEL:



**STEP 2**

PROGRAM AND CONFIGURE THE DIGITAL MULTI SENSOR (SEC-DMS) FOR "ANALOG OUTPUT" IN WEBLINK

DIGITAL MULTI SENSOR (SEC-DMS)

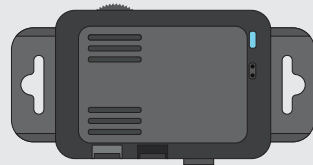

**STEP 4**

ADJUST DMS SHOCK SENSITIVITY USING THE ON-BOARD DIAL (DEFAULT).

**STEP 3**

CONNECT ALL ALARM COMPONENTS AS SHOWN.

SECURITY LED (SEC-LED)

SIREN ADAPTER (SEC-SIR-ADP)

SIREN (SEC-SIR)

INSERT PROVIDED LOOSE WIRES INTO THE BLACK 12 PIN CONNECTOR (M2) IF NEEDED.



- 08 WHITE/PURPLE•BLACK DOT - LED (-)
- 10 WHITE/BLACK•BLACK DOT - SIREN (-)
- 11 BROWN/BLACK•BLACK DOT - STARTER KILL (-)



- 10 TAN•SILVER DOT - ALARM (-)



DMS DATA CABLE

DMS ADAPTER CABLE

- WARN AWAY (-) OUTPUT - GREEN (NOT USED)
- FULL ALARM (-) OUTPUT - BLUE
- GROUND (-) INPUT - BROWN
- 12V (+) INPUT - RED

- LED (-) INPUT - YELLOW/BLUE
- SIREN (-) INPUT - YELLOW/BROWN
- 12V (+) INPUT - RED

SIREN ADAPTER CABLE

ADS-SEC WITH HCX[512]

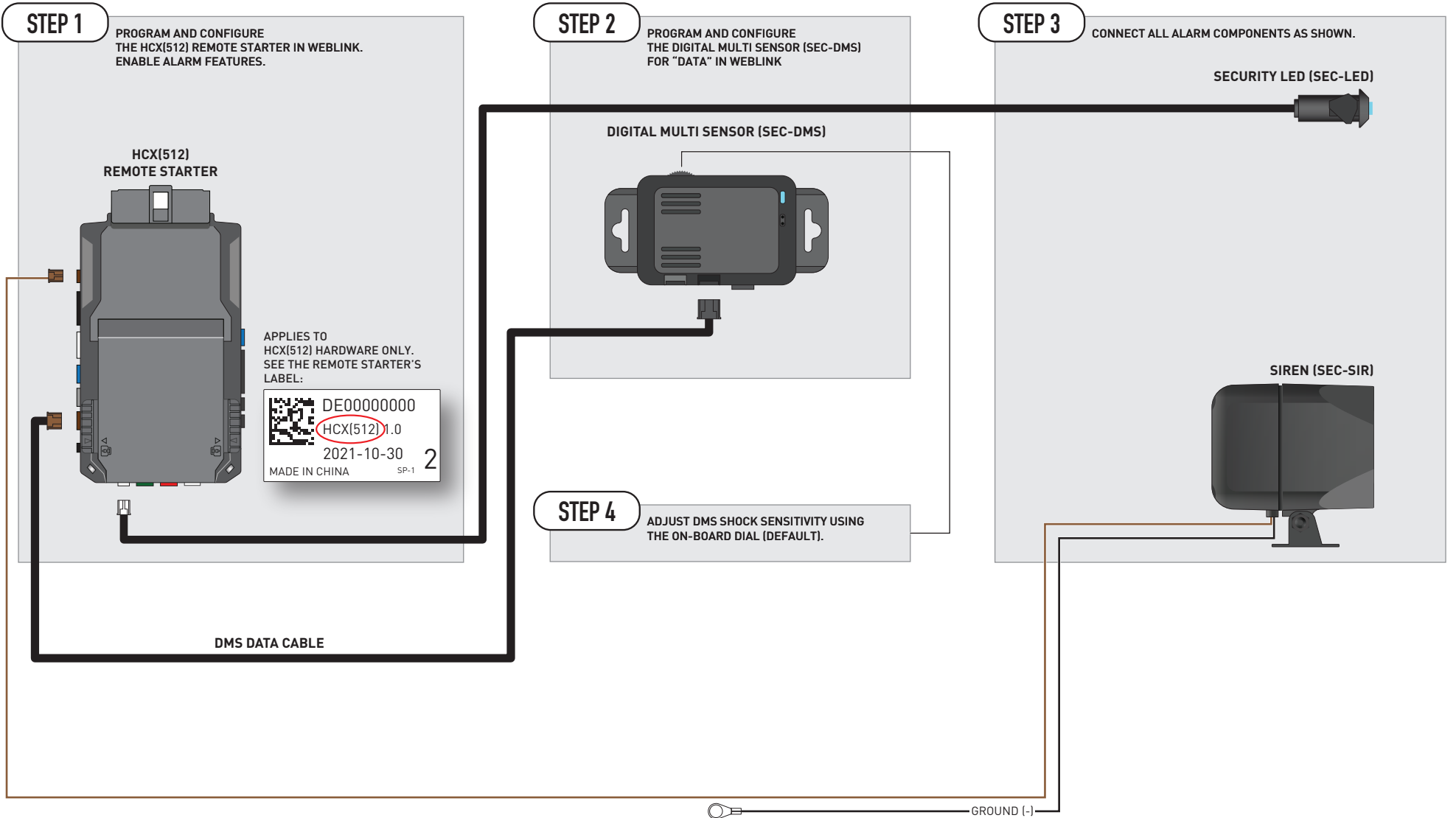

STARTER KILL - NORMALLY CLOSED

**NOTE**

THE BASIC STARTER KILL RELAY DIAGRAM SHOWN BELOW BREAKS CONTINUITY OF THE WIRE FROM THE IGNITION SWITCH TO THE STARTER MOTOR WHEN THE ALARM IS ARMED AND THE IGNITION IS TURNED ON. THE DEFAULT STARTER KILL POC (BROWN/BLACK•BLACK DOT) IS SHOWN, BUT ANY AVAILABLE POC CAN BE CONFIGURED FOR STARTER KILL.

